

m2.1 WL



Installation video
Operating video
Settings video

www.vdocyclecomputing.com/service

Preface

Congratulations

In choosing a VDO computer, you have opted for high-quality device with first rate technology.

To optimally use the computer, we recommend that you read this manual carefully. It contains full operating instructions and many useful tips.

We hope you enjoy cycling with your VDO computer.

Cycle Parts GmbH

Pack contents

First, please ensure that the contents of this pack are complete:

- 1 VDO computer, battery separate
- 1 speed transmitter, battery installed, rubber shim
- 1 universal handlebar bracket
- 1 spoke magnet (clip magnet)
- Cable ties for attaching the bracket and the transmitter
- 1 Instruction manual

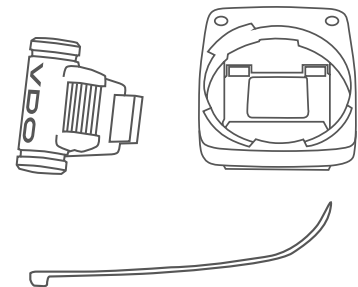
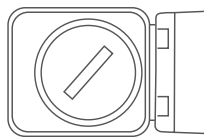
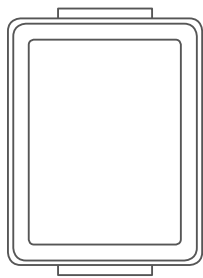

Table of contents

Display	03	Settings	11
Buttons	03	Language	11
Functions	04	Wheel circumference	12
Operation while cycling	06	Unit	15
Wireless transmission of the speed	06	Clock	16
Attaching the handlebar bracket	07	Total distance	19
Attaching the speed transmitter	08	Total ride time	20
Inserting the computer into the bracket	09	Total calorie burn	22
Testing the wireless transmission	09	Resetting trip data after the trip	23
Sleep mode and wireless receiver	10	Battery status indicator	24
		Replacing the battery in the computer	24
		Replacing the battery in the transmitter	25
		Terms of guarantee	26
		Troubleshooting	27
		Technical specifications	27

Display

The VDO M2.1 WL has a large, easy-to-read display that can be divided into three areas.

- The **top line** of the display permanently indicates the current speed. If the 12-hour clock format has been selected, “am” or “pm” appears next to the speed. The same area also shows whether kmh or mph has been selected for the speed indicator. On the left of this line are arrows that indicate whether the current speed is above or below than the average speed.
- The **middle line** of the display shows the name of the selected function in clear text.
- The **bottom line** of the display shows the value for the selected function.

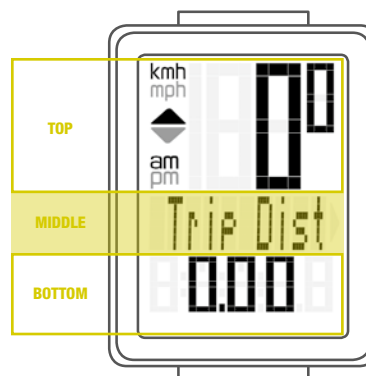

Buttons

The VDO M2.1 WL has two buttons

BIKE

In function mode:

- Access functions
- Reset trip data to zero (press and hold the button)

In setting mode:

- Scroll in the setting menu
- Change the data to be set

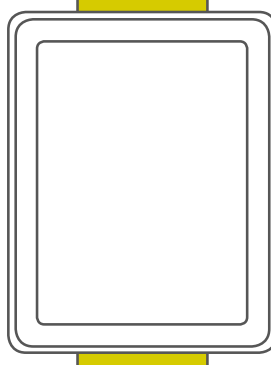

SET

In function mode:

- Scroll backwards through the functions
- Open setting mode (press and hold the button)

In setting mode:

- Open the setting
- Confirm the setting once ready
- Exit setting mode and return to function mode

Functions

The VDO M2.1 WL has the following functions

Current speed

With a wheel circumference of 2,155 mm, the maximum possible speed is 199 kmh or 124 mph.

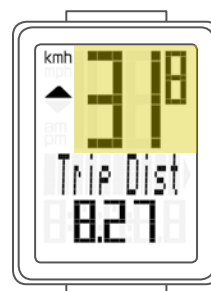

Current distance

The current distance counts up to 999.99 km or miles. If this maximum value is exceeded, the counter restarts the current distance calculation at zero.



Current ride time

The current ride time counts up to 99:59:59 HH:MM:SS. If this value is exceeded, the ride time counter restarts at zero.

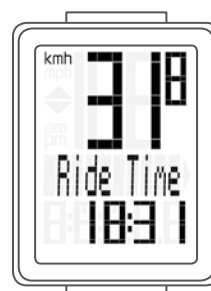

Average speed

for the current trip

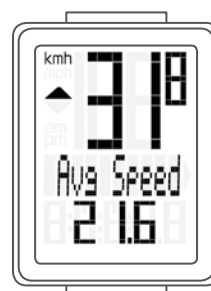

Maximum speed

for the current trip

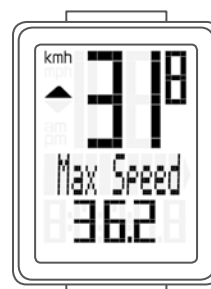

Functions

Current calorie burn

Calorie burn calculated for the current trip.



Current time

(in 24-h or 12-h format)

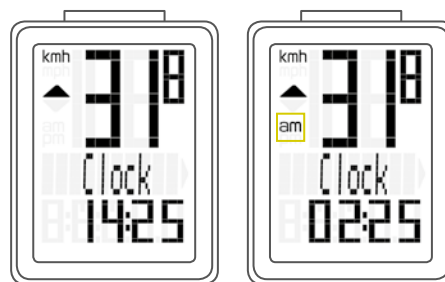

24-H format

12-H format

Total distance

(total for all day trips)

The total distance counts up to 99,999 km or miles. If this value is exceeded, the total distance counter restarts at zero.

If the unit is switched from miles to km and the conversion result is greater than 100,000 km, the counter is reset to zero.

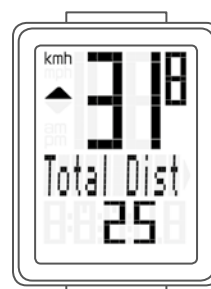

Total ride time

(total for all day trips)

The total ride time counts up to 9,999:59 HHHH:MM. If this value is exceeded, the total ride time counter restarts at zero.

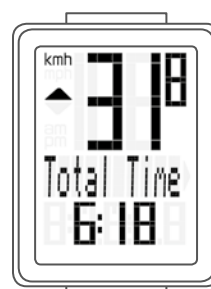

Total calories

displays the total calorie burn for all trips up to 99,999. If this value is exceeded, the total calorie count restarts at zero.

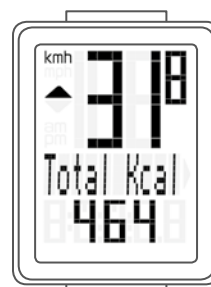

Operation while cycling

While cycling, the display functions can be accessed by pressing the **BIKE** button.

Pressing the **BIKE** button shows the next function on the display.

By pressing the **SET** button you can also **scroll backwards through the functions**.



Wireless transmission of the speed

The VDO M2.1 WL comes with analogue wireless transmission.

The wireless range is approx. 75 cm between the transmitter on the fork and the computer/receiver on the handlebars.

During attachment, make sure you attach the transmitter to the left-hand fork leg if you attach the computer to the stem or on the left of the handlebar.

If you attach the computer to the right of the handlebars, you can also attach the transmitter to the right-hand fork leg.

Note: LED front lights can interfere with analogue wireless transmission.

Attaching the handlebar bracket

You can attach the computer to the right or left of the handlebars or in the centre on the stem. Attach the handlebar bracket in the corresponding position.

STEP 1

Decide whether you want to attach the computer to the handlebars or the stem.

STEP 2

Rotate the foot of the handlebar bracket by 90° accordingly. To do so, undo the screws in the bracket, remove the foot and rotate it 90° then insert and tighten the screws again.

Attention: do not overtighten the screws.

STEP 3

Guide the cable ties through the slot in the handlebar bracket, place around the handlebars or the stem and pull (do not pull tight just yet).

STEP 4

For handlebar attachment: align the computer angle to achieve optimum readability. Now pull the cable ties tight.

Use clippers to snip off protruding ends.

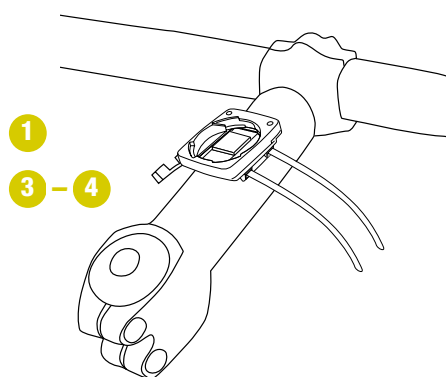
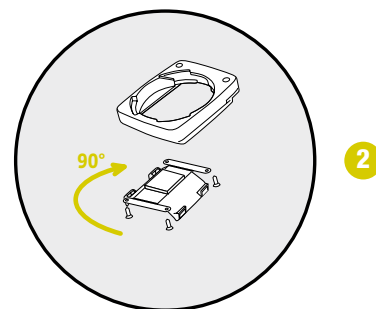
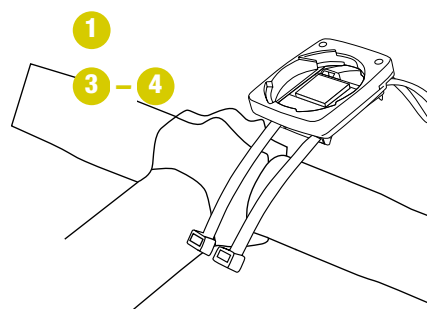

Attaching the speed transmitter

The transmitter can be attached to the fork leg on the right or left.

Note:

If you have attached the computer to the stem or the left of the handlebars, the speed transmitter **MUST** be attached to the **LEFT** fork leg.

STEP 1

Place the rubber shim under the transmitter. Fit the transmitter to the fork side that corresponds to the side on which you later want to fit the computer to the handlebars (right or left) using the cable ties supplied (loosely at first, do not pull tight just yet).

ATTENTION: The cross-hatched marking on the lid of the transmitter's battery compartment must point toward the spokes.

Depending on the available space, the transmitter can be mounted along the front of the fork, on the inside of the fork, or the back of the fork.

STEP 2

Place the spoke magnet around an outside spoke. The VDO logo of the rod-shaped magnet core should point toward the transmitter. Align the magnet with the cross-hatched sensor marking on the transmitter at a distance of 1-5 mm.

STEP 3

Align the transmitter and magnet in their final positions and fasten them in place: pull the cable ties tight and push the magnet in firmly. The transmitter should be folded down at a maximum angle of 45° to the spokes. If you cannot achieve this angle, move the transmitter down along the fork leg towards the hub until you have reduced the angle to less than 45°.

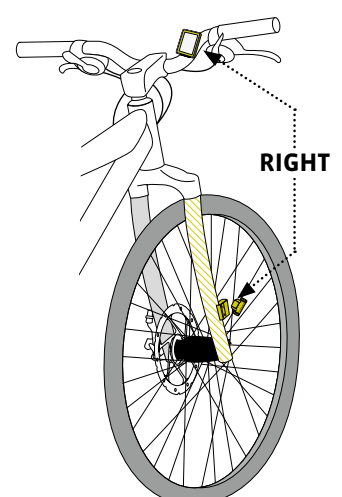
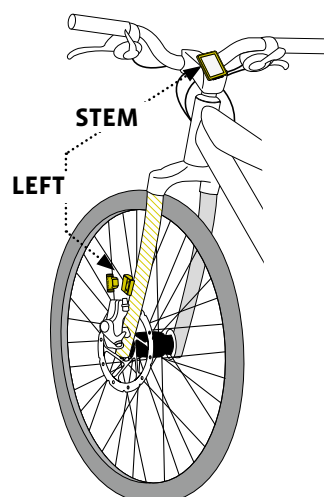
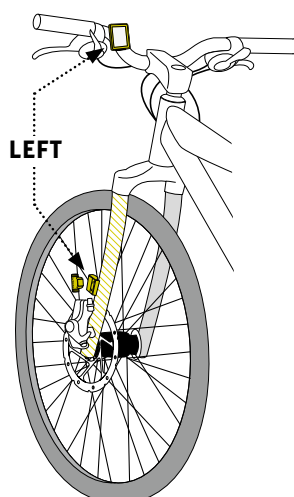
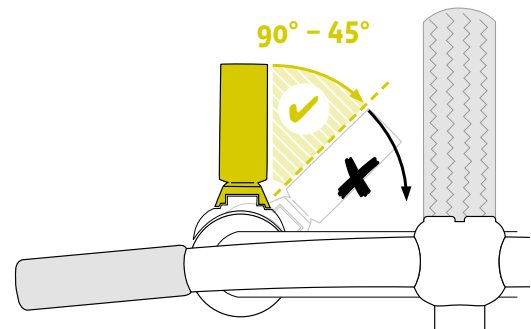
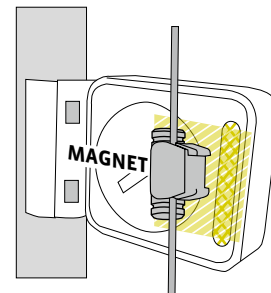
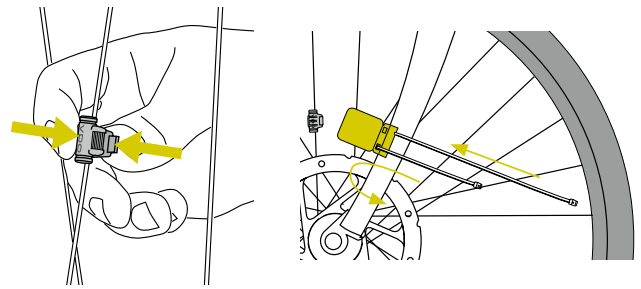

Inserting the computer into the handlebar bracket

The VDO twist-click system securely connects the computer to the handlebar bracket.

This occurs as follows:

STEP 1

Place the computer into the bracket in a 10 o'clock position.

STEP 2

Rotate the computer to the right into the 12 o'clock position and click it into the bracket system. A noticeable resistance must be overcome to move it into place.

STEP 3

To remove the computer, rotate it to the left (without pushing or pulling).

Memory aid: **R**igid to the **R**ight, **L**oose to the **L**eft

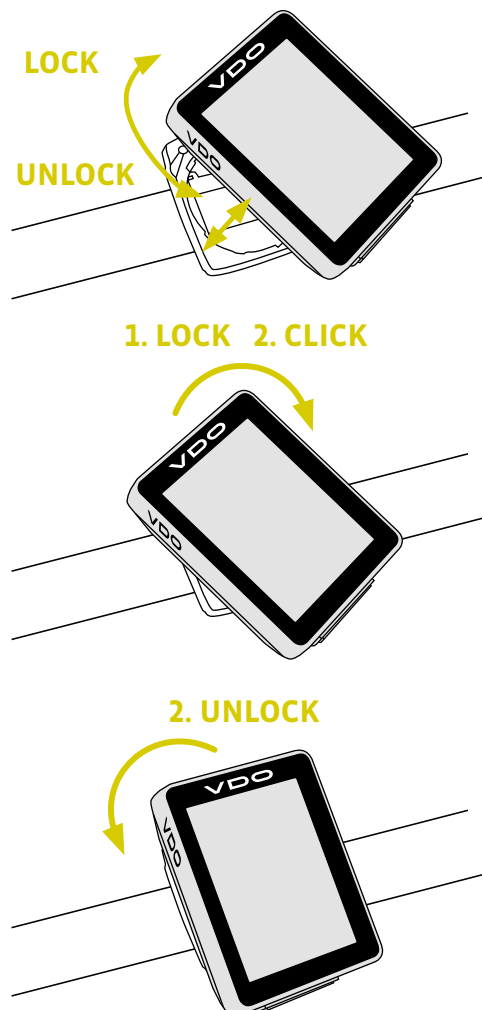

Testing the wireless transmission

Once attached, test the wireless transmission.

Do this as follows:

- Insert the computer into the bracket
- Lift and spin the front wheel
- An LED should flash on the transmitter **for a few seconds**.
Flashing LED: the transmitter is sending a signal
- A speed should now be displayed on the computer.

If no speed is displayed, there can be several reasons for this. The possible reasons are described in the **“Troubleshooting”** section.

Sleep mode and wireless receiver

If you take a break and the **M2.1 WL is still in the handlebar bracket** the computer switches to **standby mode** after **five minutes**.

The wireless receiver is still **ON**.

This can be seen from the **flashing antenna icon**.

If you now set off cycling again, the auto-start function is used. The VDO M2.1 WL instantly switches back to the function mode. The current speed is once again displayed. **This can take up to eight seconds.**



If you take a break for **more than two hours**, the wireless receiver switches off to save the battery. You can see from the display if this has happened – the flashing antenna icon no longer appears.

You must press a button before setting off again.

Once a button has been pressed, the receiver is once again activated. You can now set off again.

If you remove the VDO M2.1 WL **from the bracket**, the **wireless receiver is immediately switched off** and the computer switches to sleep mode after five minutes.



Settings – language

The following display languages can be selected for the VDO M2.1 WL:

- German
- English
- French
- Italian
- Spanish
- Dutch
- Polish

Do this as follows:

Press and hold the SET button until the settings menu opens.



“Language” appears on the display.

Press **SET** to open the language setting.
English flashes.

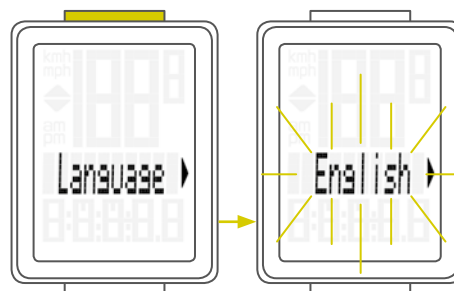

You can now press the **BIKE button** to select a different language.



Press the **SET button** to confirm your language setting.
The response “Set Ok” appears on the display.



If you want to configure further settings,
press the **BIKE button** to access these.

If you do not want to configure any other settings,
press and hold the SET button.

The settings menu closes.
The VDO M2.1 WL returns to function mode.



Settings – wheel circumference

You can set the roll circumference of your wheel on the VDO M2.1 WL.

The more accurate this setting, the more accurate your speed indicator and the measurement of the distance you have travelled.

You can find the values for your wheels in the wheel size table and set these in the device.

If your wheel size is not listed in the table, you can accurately measure the roll circumference.

This is done as follows:

STEP 1

Stand your bike up and position the front wheel so that the valve is directly on the ground. Ensure that the tyres are fully pumped up in accordance with the usage instructions. Mark the position of the valve on the ground with a line or adhesive strip.

STEP 2

Now push your bike forwards in a straight line until the valve is back on the ground after one rotation.

Again mark the position of the valve on the ground with a line or adhesive strip.

STEP 3

The distance between the two marks corresponds to your wheel circumference or wheel size in millimetres.

Tyre size	ETRTO	KMH Wheel circumference in mm	MPH Wheel circumference in inches
16 x 1.75	47-305	1,272	50.1
20 x 1.75	47-406	1,590	62.6
24 x 1.75	47-507	1,907	75.1
26 x 1.5	40-559	2,026	79.8
26 x 1.75	47-559	2,070	81.5
26 x 1.9		2,089	82.2
26 x 2.00	50-559	2,114	83.2
26 x 2.10	54-559	2,125	83.6
26 x 2.25	57-559	2,145	84.4
26 x 2.35	60-559	2,160	85.0
26 x 2.40	62-559	2,170	85.4
28 x 1.5	40-622	2,224	87.6
28 x 1.6	42-622	2,235	88.0
28 x 1.75	47-622	2,268	89.3
29 x 2.10	54-622	2,295	90.3
29 x 2.25	57-622	2,288	90.1
29 x 2.40	62-622	2,300	90.5
650 B / 27,5		2180	85,8
700 x 18C	18-622	2,102	82.8
700 x 20C	20-622	2,114	83.2
700 x 23C	23-622	2,095	82.5
700 x 25C	25-622	2,146	84.5
700 x 30C	30-622	2,149	84.6
700 x 32C	32-622	2,174	85.6
700 x 38C	38-622	2,224	87.6

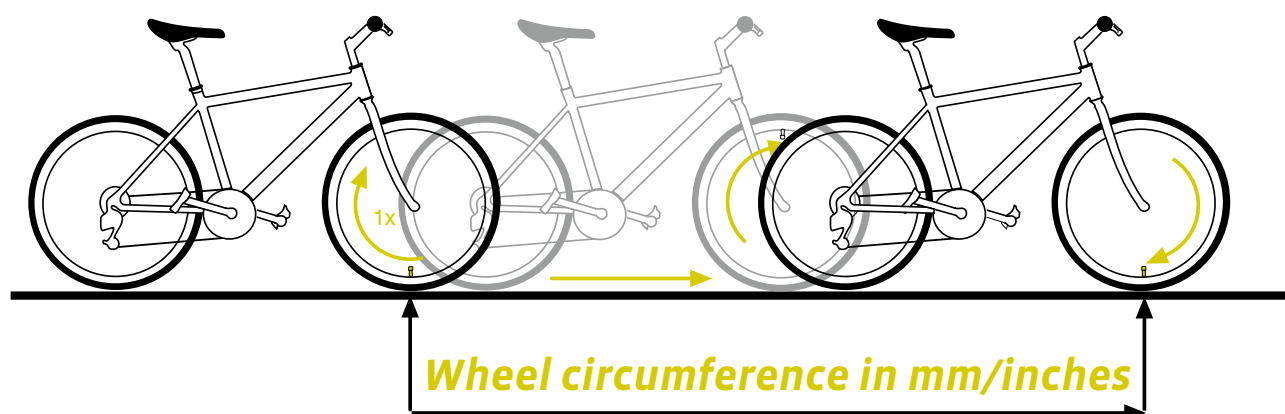

Settings – wheel circumference

How to set your wheel circumference:

Press and hold the **SET** button until the settings menu opens.



“Language” appears on the display.

Press the **BIKE** button to scroll to the setting for the wheel circumference.



Press the **SET** button to open the setting for the wheel circumference.

Setting in mm for KM



Setting in Inch for Miles



Setting in mm for KM:

The first two digits flash.

Press the **BIKE** button to set these digits to the desired value.

Setting in mm for KM



Setting in Inch for Miles



Setting in Inch for Miles:

All digits flash.

Press the **BIKE** button to set these digits to the desired value.

Setting in mm for KM:

Press the **SET** button to confirm your setting.

The third digit now flashes and is ready to be set.

Press the **BIKE** button to set this digit.

Setting in mm for KM



Settings – wheel circumference

Setting in mm for KM:

Press the **SET button** to confirm your setting.
The final digit on the right now flashes.

Press the **BIKE button** to set this digit.

Setting in mm for KM



Setting in mm for KM/ Inch for miles:

Press the **SET button** to confirm your setting.
Your wheel circumference setting is now complete.

The response **“Set Ok”** appears on the display.

If you want to configure further settings,
press the **BIKE button** to access these.

If you do not want to configure any other settings,
press and hold the SET button.
The settings menu closes.

The VDO M2.1 WL returns to function mode.



Settings – unit

Use the unit settings to specify whether the speed should be displayed in kmh or mph.

Press and hold the SET button until the settings menu opens.



“Language” appears on the display.

Press the **BIKE button** to scroll to the setting for the unit.

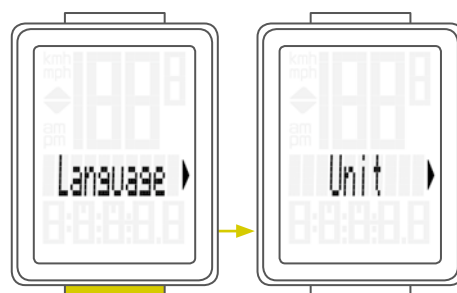

Press the **SET button** to open the unit setting.

“KMH” flashes in the top line of the display.



Press the **BIKE button** to change the unit to **“MPH”**.



Press the **SET button** to confirm the setting.

The response **“Set Ok”** appears on the display.

If you want to configure further settings, press the **BIKE button** to access these.

If you do not want to configure any other settings,

press and hold the SET button.

The settings menu closes.

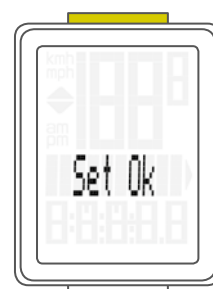

The VDO M2.1 WL returns to function mode.

Settings – clock

In the VDO M2.1 WL, you can set the time in 12-hour AM/PM format or 24-hour format.

Press and hold the SET button until the settings menu opens.

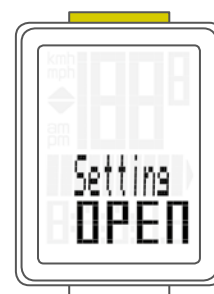

“Language” appears on the display.

Press the **BIKE button** to scroll to the setting for the time.

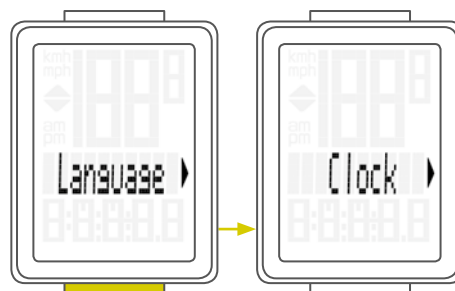

Press the **SET button** to open the setting for the time.



To switch to the 12-hour AM/PM format, press the **BIKE button**.



Settings – clock

Setting the time in 24-hour format

Press the **SET button** to confirm the selection “24”.
The hours now flash on the display.

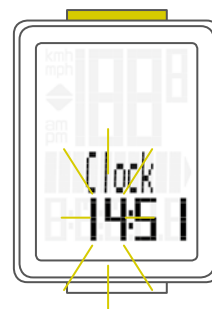

Press the **BIKE button** to set the hours.



Press the **SET button** to confirm the hour setting.

The minutes then flash.
Press the **BIKE button** to set the minutes.



Press the **SET button** to confirm the minute setting.

The response “**Set Ok**” appears on the display.
If you want to configure further settings,
press the **BIKE button** to access these.

If you do not want to configure any further settings,
press and hold the SET button.
The settings menu closes.

The VDO M2.1 WL returns to function mode.



Settings – clock

Setting the time in 12-hour AM/PM format

Press the **SET button** to confirm the selection “12”.
The hours now flash and “am” or “pm” appears on the display.

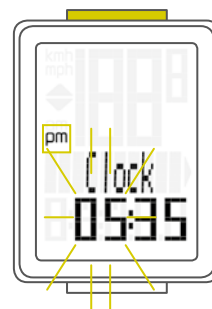

Press the **BIKE button** to set the hours.
The display information changes from “pm” to “am” at “12”.



Press the **SET button** to confirm the hour/AM-PM setting.

The minutes now flash on the display.
Press the **BIKE button** to set the minutes.



Press the **SET button** to confirm the minute setting.

The response “Set Ok” appears on the display.

If you want to configure further settings,
press the **BIKE button** to access these.

If you do not want to configure any other settings,
press and hold the SET button.
The settings menu closes.

The VDO M2.1 WL returns to function mode.



Settings – setting the total distance

You can set the total distance ridden on the VDO M2.1 WL. For example, you can enter your data here at the start of a new cycling season.

ATTENTION: the M2.1 WL has a data memory. No data is lost when the battery is replaced.

The process is as follows:

Press and hold the SET button until the settings menu opens.



“Language” appears on the display.

Press the **BIKE button** to scroll to the setting for the total distance.



Press the **SET button** to open the setting. The left digit flashes.

Press the **BIKE button** to change the digit. Once this digit has been set, confirm the setting by pressing the **SET button**. The next digit starts to flash and is ready to be set.

Press the **BIKE button** to change this digit. Once this digit has also been set, confirm the setting by pressing the **SET button**. The next digit flashes.

Once all digits have been set, confirm the setting again by pressing the **SET button**.



The response **“Set Ok”** appears on the display. The set value is stored.

If you want to configure further settings, press the **BIKE button** to access these.

If you do not want to configure any other settings, **press and hold the SET button**. The settings menu closes.

The VDO M2.1 WL returns to function mode.



Settings – setting the total ride time

You can set the total ride time on the VDO M2.1 WL.
E.g. you can set your total ride time (total ride time for all trips) at the start of the new cycling season).

ATTENTION: the VDO M2.1 WL has a data memory.
No data is lost.

The process is as follows:

Press and hold the SET button until the settings menu opens.

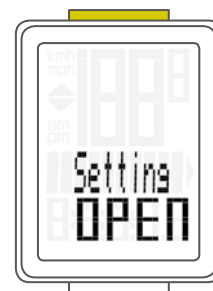

“Language” appears on the display.

Press the **BIKE button** to scroll to the setting for the total ride time.



Press the **SET button** to open the setting for the total ride time.

The left digit of the hours setting flashes and is ready to be set.

Press the **BIKE button** to set the value for this digit.
Press the **SET button** to confirm your setting.
The next digit on the left starts to flash and is ready to be set.

Press the **BIKE button** to set the value for this digit.

Press the **SET button** to confirm your setting.
Once you have set all four digits, confirm the setting again by pressing the **SET button**.



The minutes setting is then opened.



Settings – setting the total ride time

Press the **BIKE button** to set the minutes.
Once the minutes have been set, confirm the setting
by pressing the **SET button**.



The response **“Set Ok”** appears on the display.

If you want to configure further settings,
press the **BIKE button** to access these.

If you do not want to configure any other settings,
press and hold the SET button.
The settings menu closes.

The VDO M2.1 WL returns to function mode.



Settings – total calorie burn

You can set the total calorie burn on the VDO M2.1 WL.
E.g. you can set your total calorie burn at the start of the new cycling season.

ATTENTION: the VDO M2.1 WL has a data memory.
No data is lost.

The process is as follows:

Press and hold the SET button until the settings menu opens.



“Language” appears on the display.

Press the **BIKE button** to scroll to the settings for the **Total Kcal** (total calorie burn).



Press the **SET button** to open the setting.
The left digit flashes and is ready to be set.

Press the **BIKE button** to change the digit.
Once this digit has been set, confirm the setting
by pressing the **SET button**.
The next digit starts to flash and is ready to be set.

Press the **BIKE button** to change this digit.
Once this digit has also been set, confirm the setting
by pressing the **SET button**.
The next digit flashes.

Once you have set all four digits, confirm the setting again
by pressing the **SET button**.

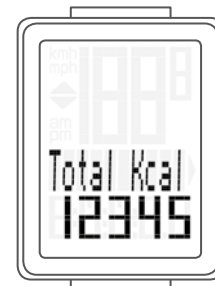

The response “Set Ok” appears on the display.
The set value is stored.

If you want to configure further settings,
press the **BIKE button** to access these.

If you do not want to configure any other settings,
press and hold the SET button.
The settings menu closes.

The VDO M2.1 WL returns to function mode.



Resetting trip data after the trip

After each day trip, you can reset the data for this day trip to zero. The VDO M2.1 WL is then ready for the next day trip.

ATTENTION: your total distance (total number of kilometres ridden) and total ride time and total calorie burn are not reset to ZERO.

The process is as follows:

Press and **hold the BIKE button for a few seconds**. The text **“RESET Tour Data”** appears on the display.

If you **continue to hold down the BIKE button**, the trip data is now reset to zero.

The following data is reset to zero:

- Distance
- Ride time
- Calories
- Average speed
- Maximum speed



Low battery indicator

The M2.1 WL has a low battery warning.
The text **“Computer low”** appears on the display.

Press the **BIKE button** to acknowledge this low battery warning.
You can keep using the cycle computer for approx. a week.
Replace the battery as soon as possible on seeing the low battery warning.

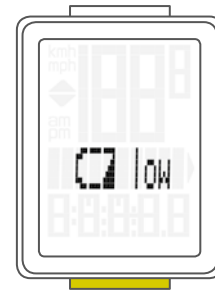

Replacing the battery in the computer

To ensure your cycle computer is fully functional,
we recommend **replacing the battery annually**.

ATTENTION: your settings, total distance, total calorie burn and total ride time information remain stored when you replace the battery. **NO** data is lost.

You need a 3 V 2032 battery.
We recommend using a branded battery from Sony, Panasonic, Varta or Duracell.

The process is as follows:

STEP 1

Use a coin to remove the battery compartment cover.

STEP 2

Remove the dead battery.

ATTENTION: Wait for **10 seconds** before inserting the new battery. The electronics need this time to recognise that the battery is being changed.

STEP 3

Insert the battery into the computer housing with the +pole up.
Ensure that the battery is not tilted.
Ensure that the rubber seal lies smoothly on the lid of the battery compartment.

STEP 4

Insert the battery compartment cover into the opening and use a coin to turn it to right as far as it will go.

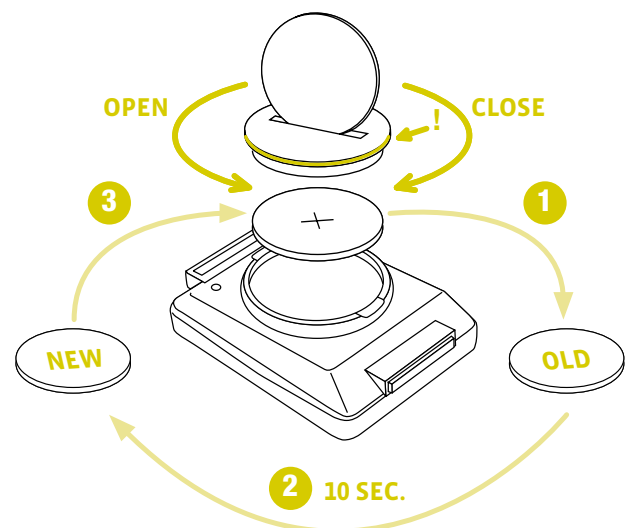

Replacing the battery in the speed transmitter

The battery in the speed transmitter **should be replaced annually** to guarantee seamless wireless transmission.

You need a 3 V 2032 battery.
We recommend using a branded battery from Sony, Panasonic, Varta or Duracell.

The process is as follows:

STEP 1

Use a coin to remove the battery compartment cover.

STEP 2

Remove the dead battery.

ATTENTION: Wait for 10 seconds before inserting the new battery. The electronics need this time to recognise that the battery is being changed.

STEP 3

Insert the battery into the transmitter housing with the +pole up.
Ensure that the battery is not tilted.
Ensure that the rubber seal lies smoothly on the lid of the battery compartment.

STEP 4

Insert the battery compartment cover into the opening and use a coin to turn it to right as far as it will go.

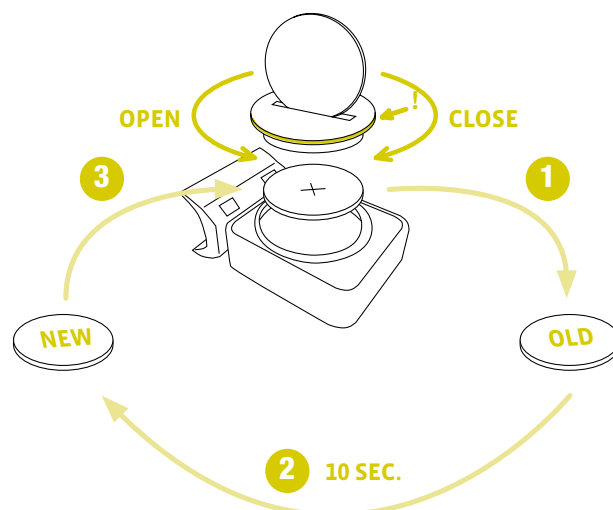

Terms of guarantee

VDO Cycle Parts offers a **2-year guarantee** on your VDO computer, **starting from date of purchase**. This guarantee covers material and processing defects on the computer itself, the sensor/transmitter and the handlebar bracket. Cables, batteries and mounting materials are not covered by the guarantee.

The guarantee is only valid if the affected components have not been opened (exception: computer's battery compartment), no force has been used and there is no sign of wilful damage.

Please store the purchase receipt in a safe place as it must be submitted in the event of a complaint.

If your complaint is legitimate, you will receive a comparable replacement device. You are not entitled to a replacement of the identical model if the model in question is no longer in production due to a model change.

Please contact the dealer from whom you purchased the device for all complaints and guarantee claims. Alternatively, send your complaint directly to:

Cycle Parts GmbH

Le Quartier Hornbach 13
67433 Neustadt/Weinstrasse

If you have any technical questions, please do not hesitate to call our hotline on:

+49 (0) 63 21- 95 82 7 - 10

+49 (0) 63 21- 95 82 7 - 18

**Our telephone hotline is available to assist you
between the hours of
9:00-12:00, Monday to Friday
service@cycleparts.de**

Additional technical information is available at:
www.vdocyclecomputing.com

We reserve the right to make technical changes in the course of further development.

Troubleshooting

Error	Possible cause	Correction
Half segments on the display (e.g. after a battery change)	Computer software not running correctly after battery change	Remove and re-insert the battery
No speed displayed	Distance from sensor to magnet too great	Correct the sensor and magnet positions
No speed displayed	Computer not properly clicked into the handlebar bracket	Insert the computer into the handlebar bracket and rotate it as far as possible ("click")
No speed displayed	Wheel circumference is not correctly set or is at zero	Set the wheel circumference
No speed displayed	Battery in the transmitter is dead	Replace the battery in the transmitter
Display becomes weak	Battery dead	Check the battery, replace if nec.

Technical specifications

Computer:

Approx. 49 H x 38 W x 16 D mm

Display:

H approx. 39 mm, W approx. 29 mm

Computer weight:

Approx. 28 g

Handlebar bracket weight:

Approx. 10 g

Speed transmitter weight:

Approx. 20 g

Computer battery:

3V, type 2032

Computer battery service life:

Approx. 1 year (approx. 10,000 km/6,000 mi)

Speed transmitter battery:

3V, type 2032

Speed transmitter battery life:

Approx. 1.5 year (approx. 15,000 km/9,000 mi)

Wireless transmission ranges:

Speed transmitter: 75 cm

Temperature indicator range on the display:

-20°C to +70°C/ -4°F to +158°F

Speed range for wheel size 2,155 mm:

Min 2.5 km/h,

Max 199 km/h

Ride time measurement range:

Up to 99:59:59 HH:MM:SS.

Trip distance odometer measurement range:

Up to value 999.99 km or mi

Total km measurement range:

Up to value 99,999 km or mi

Total ride time measurement range:

9999:59 HHHH:MM

Calorie measurement range:

Up to value 99.999 calories

Total calorie measurement range:

Up to value 99.999 calories

Wheel circumference setting range:

From 100 mm to 3999 mm (3.9 to 157.4 inches)

Correct disposal of this product (electrical waste)



(To be used in EU countries and other European countries with a separate collection system). The labelling on the product and the relevant literature indicates that it must not be disposed of with normal household waste at the end of its service life. Please dispose of this device separately to other waste so as not to harm the environment or human health through uncontrolled waste disposal. Recycle the device to promote the sustainable reuse of material resources. Private users should contact the retailer from whom they purchased the product or the responsible authorities to find out how they can recycle the device in

an environment-friendly manner. Commercial users should contact their suppliers and consult the conditions of the sales agreement. This product must not be disposed of with other commercial waste.

EU declaration of conformity

We, CYCLE PARTS GmbH, Le Quartier Hornbach 13, D-67433 Neustadt/Weinstraße, declare that when used as intended, the VDO cycle computers with wireless transmission VDO M2.1 WL and the A1 transmitter comply with the essential requirements established in Article 3 of the R&TTE Directive 1999/5/EC.

The declaration of conformity can be viewed at: www.vdocyclecomputing.com.



Neustadt, October 2013

FCC-Addendum

This device complies with part 15 of the FCC Rules. Operation is subject to the following two conditions:

- (1) This device may not cause harmful interference, and
- (2) this device must accept any interference received, including interference that may cause undesired operation.

NOTE: This equipment has been tested and found to comply with the limits for a Class B digital device, pursuant to part 15 of the FCC Rules. These limits are designed to provide reasonable protection against harmful interference in a residential installation. This equipment generates, uses and can radiate radio frequency energy and, if not installed and used in accordance with the instructions, may cause harmful interference to radio communications. However, there is no guarantee that interference will not occur in a particular installation.

If this equipment does cause harmful interference to radio or

television reception, which can be determined by turning the equipment off and on, the user is encouraged to try to correct the interference by one or more of the following measures:

- Reorient or relocate the receiving antenna.
- Increase the separation between the equipment and receiver.
- Connect the equipment into an outlet on a circuit different from that to which the receiver is connected.
- Consult the dealer or an experienced radio/TV technician for help.

Changes or modifications not expressly approved by the party responsible for compliance could void the user's authority to operate the equipment.

IC-Addendum

This device complies with Industry Canada licence-exempt RSS standard(s).

Operation is subject to the following two conditions:

- (1) This device may not cause interference, and

- (2) this device must accept any interference, including interference that may cause undesired operation of the device.

This Class digital apparatus complies with Canadian ICES-003.



Cycle Parts GmbH

Le Quartier Hornbach 13
67433 Neustadt/Weinstrasse (Germany)

+49 (0) 63 21- 95 82 7 - 0

www.vdocyclecomputing.com